



The software interface shows a menu bar with 'Home', 'Sequence', 'Results', and 'Settings'. Below the menu is a toolbar with icons for 'New', 'Edit', 'Remove', 'Timer', 'Configuration Settings: On/Off', and 'Run View'. The main window displays a table of experimental runs with the following data:

Channel	Unit	Address	Type	Booked	Begin	Status	Exit Condition	End	User	Level	Group	Sample	Meth.Name	Meth.Type	Meth
001	3	0	OGFO5A	Girard je...	2013-01-23 16...	Buoy			Girard jean-ma...	Administrator	Informatique	XM256	chrono.flw		0000
002	3	1	OGFO5A	Girard je...	2013-01-23 16...	Buoy			Girard jean-ma...	Administrator	Informatique	iso	chrono.flw		0000
003	3	2	OGFO5A	Girard je...	2013-01-23 16...	Buoy			Girard jean-ma...	Administrator	Informatique	lrim	chrono.flw		0000
004	3	3	OGFO5A	Girard je...	2013-01-23 16...	Buoy			Girard jean-ma...	Administrator	Informatique	fdfd	chrono.flw		0000
005	2	0	OGF100		2012-12-07 11...	Finished	Normally	2012-12-07 12...	Girard jean-ma...	Administrator	Informatique	kimkim	New 1.flw		2012

Below the table is a 'Real Time Curves' window containing ten subplots, each titled '[2] Chrono Amperometry'. Each plot shows 'Current density [µA/cm²]' on the y-axis (ranging from -10 to 0) and 'Time [sec]' on the x-axis (ranging from 0 to 120). The plots show a characteristic step-like decrease in current density over time, typical of chronoamperometry.

Getting Started with OrigaFlex and OrigaViewer

ElectroChem
OrigaLys

CONTENTS

1. WELCOME	5
2. ASSEMBLING THE ORIGAFLEX UNITS	7
3. CONNECTING THE ELECTRODES TO THE ORIGAFLEX UNITS	8
3.1 DISPOSITION AND ALLOCATION OF SOCKETS	8
3.2 ELECTRODE CONNECTIONS FOR 1 MEASUREMENT CHANNEL	9
3.2.1 2 electrode measurement cell	9
3.2.2 3 electrode measurement cell	9
3.2.3 4 electrode measurement cell	10
3.3 MEASUREMENT / IMPOSING VOLTAGES AND CURRENTS	10
3.4 CONFIGURATIONS USING SEVERAL WORKING ELECTRODES	11
4. USING THE ORIGAFLEX BUILT-IN DUMMY CELL.....	12
5. CONNECTING THE ORIGAFLEX DRIVE UNITS TO THE PC.....	13
5.1 INDIVIDUAL SETUP	13
5.2 NETWORK SETUP	13
5.3 OTHER REAR PANEL SOCKETS.....	13
6. CONNECTING THE ORIGAFLEX DRIVE UNIT TO THE MAINS	14
7. STARTING ORIGAVIEWER FOR THE FIRST TIME	15
8. CONFIGURATING EACH ORIGAFLEX SYSTEM	17
9. THE ORIGAVIEWER MAIN WINDOW	19
9.1 ORIGAVIEWER BUTTON (REF. 1).....	19
9.2 RIBBON (REF. 2).....	20
9.3 OUTPUT VIEW FRAME (REF. 3)	21
9.3.1 Operations on Output view frames	21
9.4 MAIN FRAME (REF. 4)	22
9.5 STATUS BAR (REF. 5)	22
9.6 PROPERTIES TOOLBOX (REF. 6).....	22
9.6.1 Operations on Properties toolboxes.....	22
9.7 QUICK ACCESS TOOLBAR (REF. 7)	23
10. EDITING AND RUNNING MY FIRST EXPERIMENT.....	24
10.1 DECLARING THE ORIGAFLEX SYSTEM	24
10.2 EDITING THE CHANNEL PARAMETERS	24
10.3 CREATE AN EXPERIMENT	27
10.4 CREATE A CONDITIONAL LOOP SEQUENCE	29
10.5 EDIT EACH METHOD OF THE EXPERIMENT.....	32
10.6 SAVING AND RENAMING THE EXPERIMENT.....	32
10.7 RUNNING THE EXPERIMENT.....	33
11. LOADING CURVES IN DEFERRED TIME	34
12. SEARCHING RESULTS	35
13. QUITTING ORIGAVIEWER	36

LIST OF FIGURES

Figure 1: Individual setup	5
Figure 2: Network setup	5
Figure 3: Origaflex assembly	6
Figure 4: Assembling the Origaflex units	7
Figure 5: Connecting the electrodes to the Origaflex (here unit no. 8)	8
Figure 6: Origaflex rear panel connections	13
Figure 7: Connecting the Origaflex to the mains	14
Figure 8: The Configuration window	17
Figure 9: Main window	19
Figure 10: Ribbon	20
Figure 11: Output view frame	21
Figure 12: Properties Toolbox	22
Figure 13: Search results.....	35

I. Welcome

The Origaflex and Origaviewer multi-channel system consists of Origaflex assemblies connected to a PC through Ethernet cables. The PC is fitted with Origaviewer that handles a database enabling to run up 256 experimental sequences simultaneously and collect result data. This Multi-channel system can be setup in 2 ways:

- Individual setup: one Origaflex assembly (ref.4) is connected to the PC (ref.1) using a RJ45 Ethernet crossover cable (ref.2)

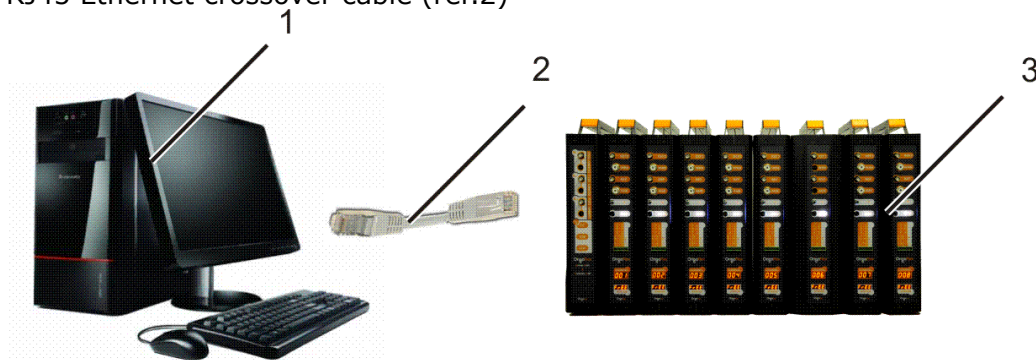

Figure 1: Individual setup

- Network setup: the PC (ref.1) is connected to a network router (ref.5) using a RJ45 Ethernet standard cable (ref.4). The router (ref.4) is connected to each Origaflex assembly (ref.3) using RJ45 Ethernet standard cables (ref.4). Up to 26 Origaflex assemblies can be setup with the help of network switches.

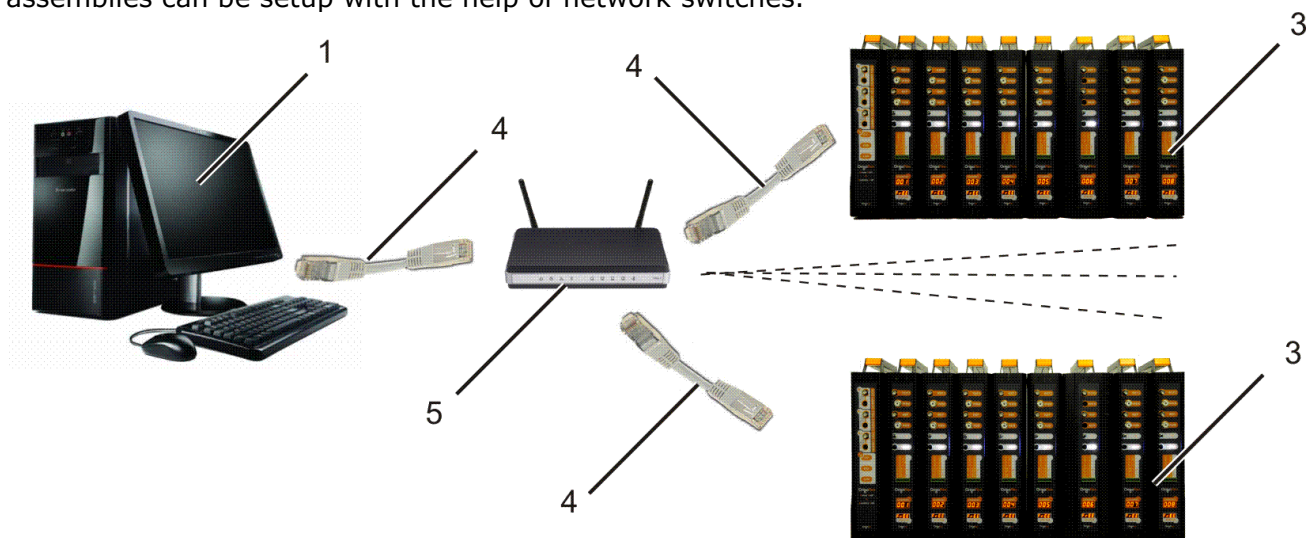

Figure 2: Network setup

An Origaflex assembly consists of:

- one drive unit (ref. 6) which powers the Origaflex units and handles a built-in 3-function (CV/EIS/LIN) dummy cell,
- up to 10 modular Origaflex units (ref. 7) to be added to the drive unit.

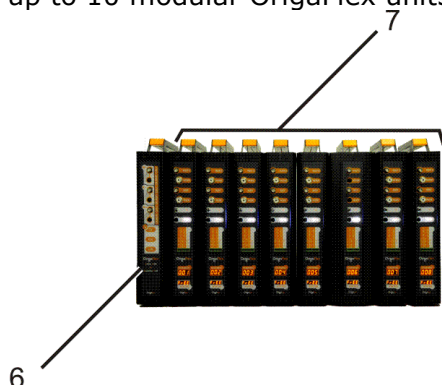

Figure 3: Origaflex assembly

Each Origaflex assembly is identified in the PC data base by one IP fixed address (192.168.0.x). This IP address is assigned to the drive unit.

Different Origaflex units are available ranging from 100 mA up to 5 A in compliance currents as shown on the table below.

	Max. current	Current ranges	Applied voltage	Auxiliary voltage
Origaflex 100	100 mA	7 ranges 100 nA > 100 mA	± 15 V	± 20 V
Origaflex 500	500 mA	7 ranges 500 nA > 500 mA	± 15 V	± 20 V
Origaflex 01A	1 A	7 ranges 1 µA > 1 A	± 15 V	± 20 V
Origaflex 05A	5 A	4 ranges 5 mA > 5 A	± 15 V	± 20 V
Origaflex 10A	100 mA	4 ranges 10 mA > 10 A	± 15 V	± 20 V

2. Assembling the OrigaFlex units

You can connect up to 10 OrigaFlex units to the drive unit.

Each unit is fitted with a female socket (ref.1) on the right side and an associated male socket (ref.2) on the left side. The OrigaFlex drive unit is only fitted with a female plug on the right side. The OrigaFlex units are assembled by plugging these sockets together.

Start by plugging the first OrigaFlex unit (ref.4) to the drive unit (ref.3) then plug the other units one by one.

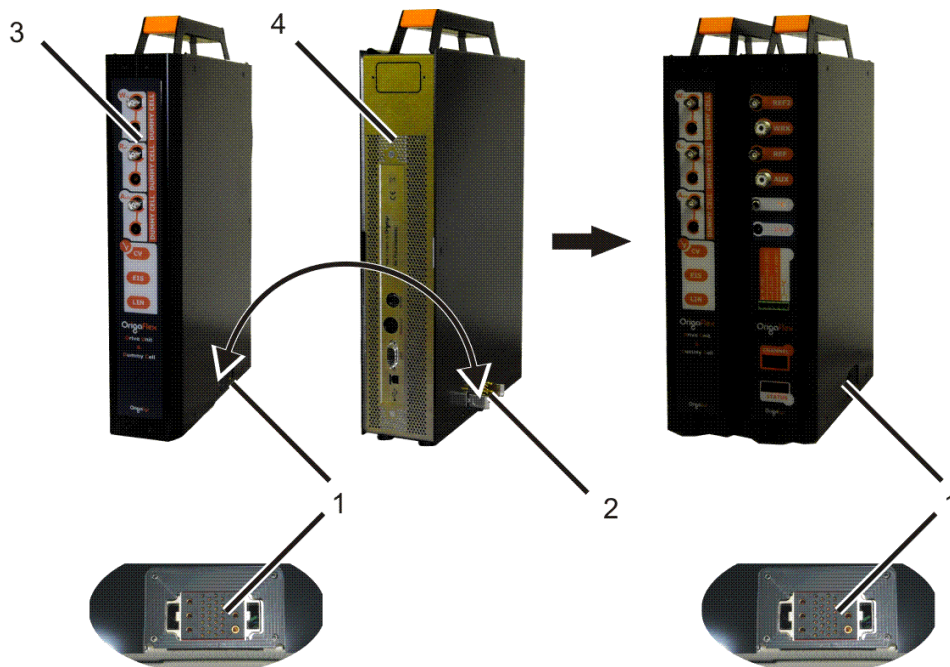

Figure 4: Assembling the OrigaFlex units

Limitations:

Up to 10 OrigaFlex can be assembled to the same drive unit provided that the total current output does not exceed 20 A.



Examples:

10 OrigaFlex 1A (10A), 3 OrigaFlex 5A + 7 OrigaFlex 500mA ($3 \times 5 + 7 \times 0.5 = 18.5$ A < 20 A) can be assembled to a same drive unit.

5 OrigaFlex 5A cannot be assembled to a same drive unit ($5 \times 5 = 25$ A > 20 A)..

3. Connecting the electrodes to the Origaflex units

Connect the electrodes of the electrochemical cell to each Origaflex unit using a 2, 3 or 4-electrode setting. Generally a 3-electrode setting is used and connected as follows:

- The working electrode to the WORK socket (ref. 1),
- The auxiliary electrode to the AUX socket (ref. 3),
- The reference electrode to the REF socket (ref. 2).

On high resistive electrolytes are used, you can ground the cell by placing it inside a metal casing connected to the GND socket (ref. 4).

If you want to measure temperatures using a temperature measuring probe (CTN or Pt-1000), connect it to RCA socket (ref. 5).



Depending on the Origaflex used, the WORK and AUX electrode inputs are fitted with BNC, PL259 or banana sockets.

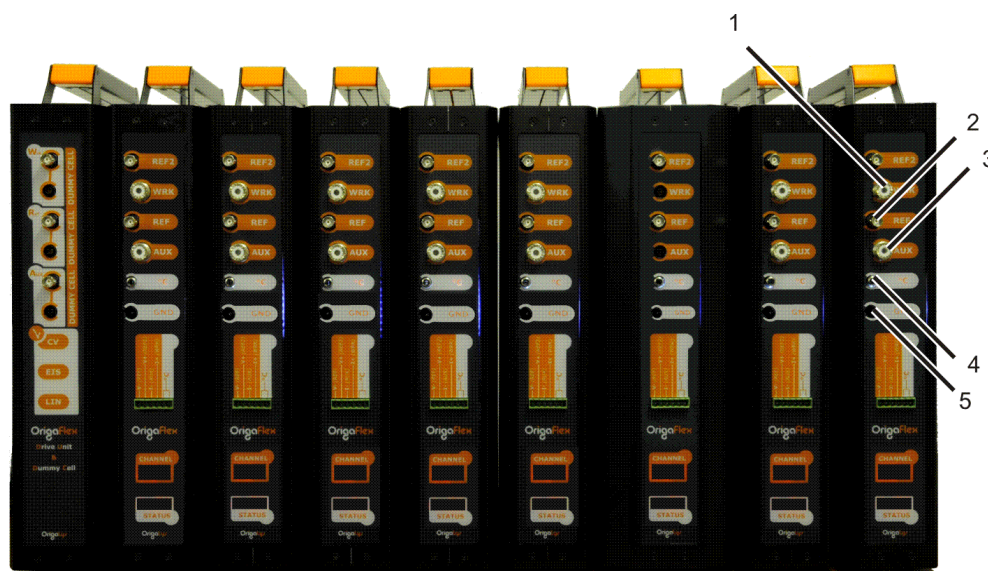

Figure 5: Connecting the electrodes to the Origaflex (here unit no. 8)

3.1 DISPOSITION AND ALLOCATION OF SOCKETS



Electrode connection sockets:

- **WR** : Working electrode.
- **Ref2** : input used in 4-pole measurement setup or for the connection of a second reference electrode.
- **REF** : Reference electrode input
- **AUX** : Counter electrode output (connected to the instrument electrical zero)
- **C** : Temperature probe (CTN or Pt-1000).
- **GN** : Electrical zero (ground) of the instrument. Can be connected to a Faraday cage for example.

Note: All socket shieldings are connected to the instrument electrical zero.

3.2 ELECTRODE CONNECTIONS FOR I MEASUREMENT CHANNEL

3.2.1 2 electrode measurement cell

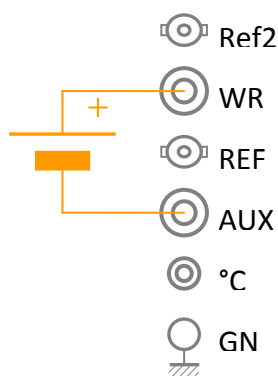

« - » terminal to the ground
« **Normal 2** »

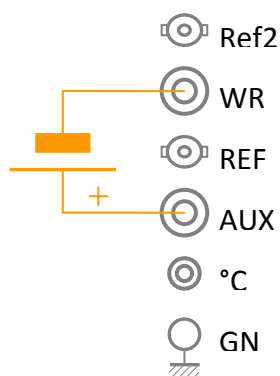

« + » terminal to the ground
« **Inverted 2** »

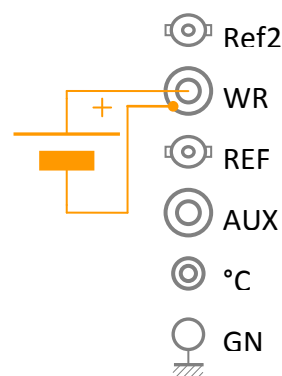

Use of a coaxial cable
(100mA to 1A versions)

3.2.2 3 electrode measurement cell

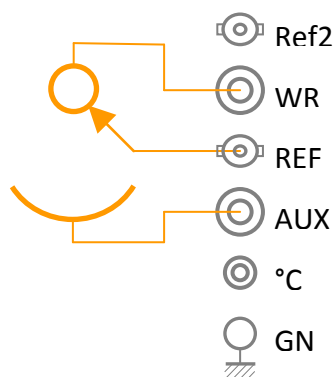

Standard configuration
« **Normal 3** »

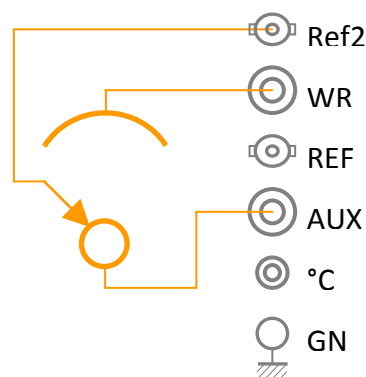

Working electrode to the ground
« **Inverted 3** »

3.2.3 4 electrode measurement cell

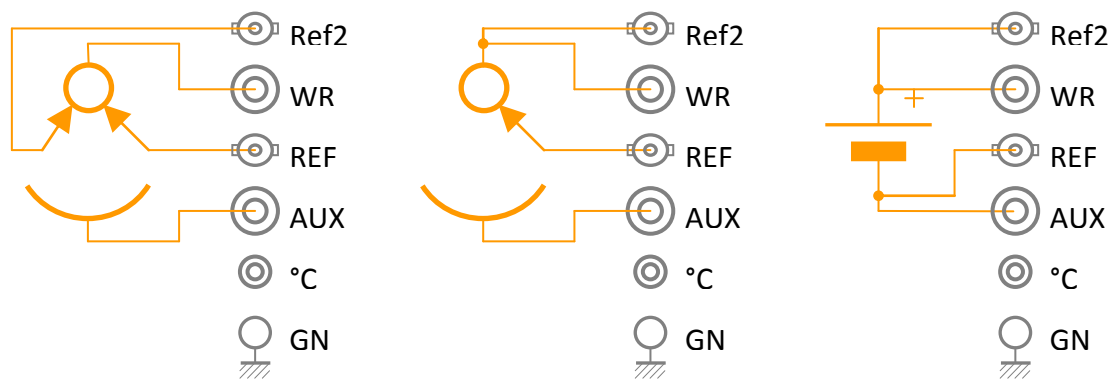

2-reference measurement cell
« Normal 4 »

3 electrodes + « current sense »
« Normal 4 »

2 electrodes, « 4 points » meas.
« Normal 4 »

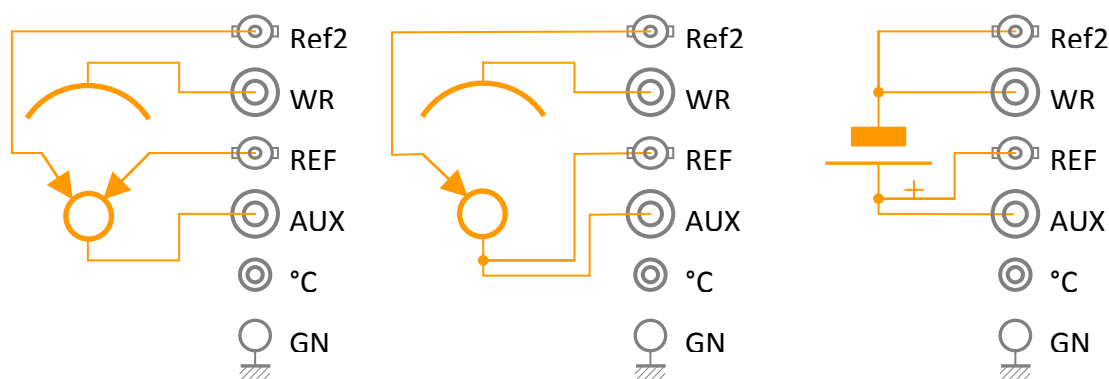

2-reference cell
« Inverted 4 »

3 electrodes + « current sense »
« Inverted 4 »

2 electrodes, « 4 points » meas.
« Inverted 4 »

3.3 MEASUREMENT / IMPOSING VOLTAGES AND CURRENTS

The sketch below shows both location and direction of imposed and measured signals. It also shows where the electrodes are connected depending on cell configuration selected:

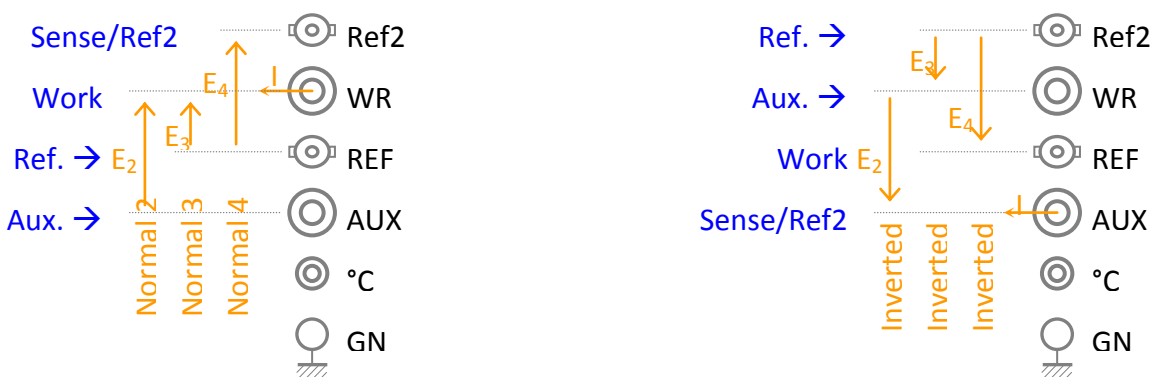

« Normal » Configuration

« Inverted » Configuration

Recall:

The « AUX » socket is connected to the electrical zero (ground) of the instrument. The ground is also earthed.

In « Cell off » mode or if the instrument is not powered, all electrode inputs/outputs are physically disconnected apart from the « AUX » which remains connected to the electrical zero.

3.4 CONFIGURATIONS USING SEVERAL WORKING ELECTRODES

Example of an 8-working electrode cell using the same reference and counter electrodes.

« Working » channel defined in « Normal 3 » mode

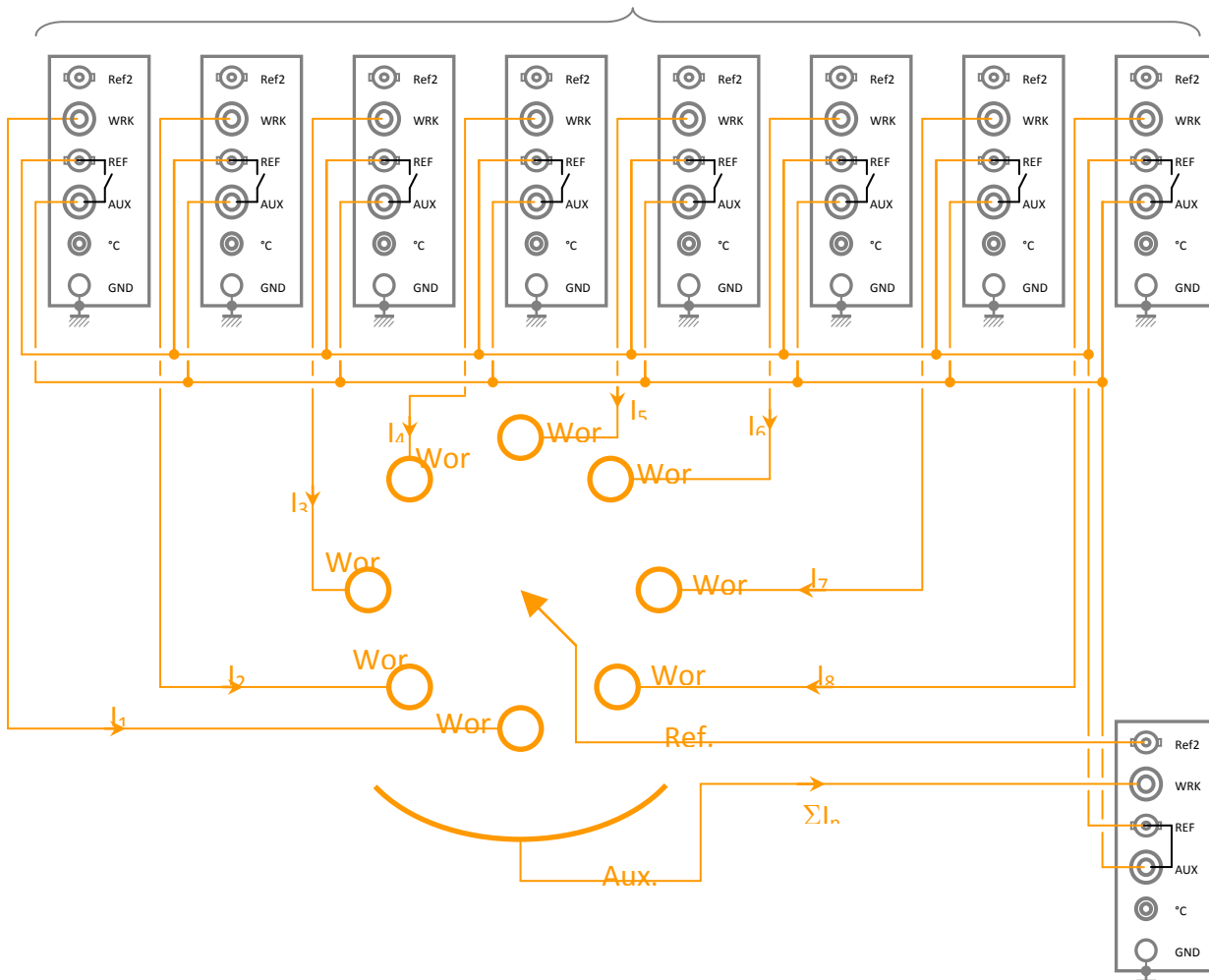

« AUX » channel defined in « Inverted 3 » and « Addition » modes

Important:

the « AUX » channel must be able to accept the addition of all currents supplied at each working electrode.

Note:

in this configuration, the « Compliance Voltage » specification is increased from 20 V to 35 V!

4. Using the OrigaFlex built-in dummy cell

The OrigaFlex drive unit is fitted with a built-in 3-function dummy cell which can be used to replace the electrochemical cell by R or RC circuitries. This enables to test channels correct working order.

The 3 available functions are:

- LIN (linear). A 33 KOhm resistor is placed in the Auxiliary electrode circuitry.
- CV (Cyclic Voltammetry). The measured current as a function of imposed potential has the following shape:

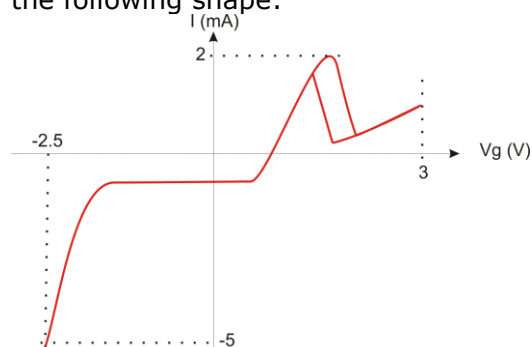

- EIS (Electrochemical Impedance Spectroscopy). The following RC circuitry is used:

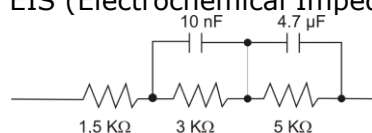

The dummy cell operating mode must also be activated for the OrigaFlex in the **Configuration** window of OrigaViewer. See [Configuring each OrigaFlex system](#).

5. Connecting the Origaflex drive units to the PC

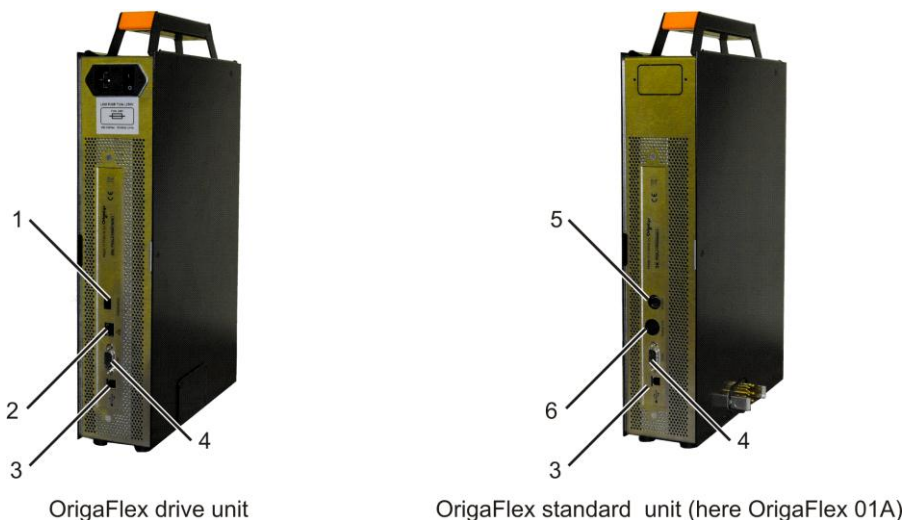

Figure 6: Origaflex rear panel connections

5.1 INDIVIDUAL SETUP

Here the Origaflex multi-channel system is connected directly to the PC fitted with Origaviewer software.

Connect the RJ45 Ethernet socket (ref.1) on the rear panel of the Origaflex drive unit to the equivalent Ethernet port on the PC. Use an Ethernet crossover cable for that connection.

5.2 NETWORK SETUP

Here the Origaflex multi-channel system belongs to a network which can be the intranet network of your company. Each Origaflex multi-channel is connected to a network router itself connected to PC's fitted with Origaviewer software.

- Connect the RJ45 Ethernet socket (ref.1) on the rear panel of the Origaflex drive unit to an Ethernet port of the router. Use a standard (direct) Ethernet cable for that connection.
- Repeat this operation for each Origaflex multi-channel system. Only the Origaflex drive unit is to be connected to the router.
- Connect the RJ45 Ethernet socket on the PC to an Ethernet port of the router. Use also a standard (direct) Ethernet cable for that connection.

Network switches can also be setup in order to increase the number of available Ethernet ports.

5.3 OTHER REAR PANEL SOCKETS

Ref.	Auxiliary voltage
1	Extension port. Used for connection to peripheral accessories. Please consult us for more information
3	Serial port. This port is dedicated to programmer or maintenance purposes (update of the Origaflex embedded software for example)..
4	USB 2.0 port. Used for connection to an USB port of the PC fitted with Origamaster 5. The Origaflex unit can be controlled individually without the use of a database (and Origaviewer).
5	Power 6-pin min DIN socket. Used for connection to peripheral such as stirrers, Origamµ, rotating disk electrodes).
6	Analog Input/Output 8-pin DIN socket for connection of external peripherals (Origamµ for example).

6. Connecting the OrigaFlex drive unit to the mains

Connect the OrigaFlex drive main socket (ref. 1) to the mains using the line cord provided.
Switch on the OrigaFlex: Turn I/O switch (ref. 2) to I.



Figure 7: Connecting the OrigaFlex to the mains

For each OrigaFlex unit including the drive unit:

- the ground input light(ref.3) is lit,
- the channel panel (ref.4) displays "----",
- the status panel (ref.5) displays "free".

You are now ready to run the PC and OrigaViewer.

7. Starting Origaviewer For the first time

1. Start Origaviewer.



Click the Origaviewer icon in the PC Desktop .

The Origaviewer name and software version are displayed for a short time then the Origaviewer Main window appears.



You can also pin the Origaviewer execution file to your taskbar or Start menu.

2. Log you on with the Administrator user account provided:



- Click the **Unlock** icon of the Home Ribbon .

- In the **User Identification** box, enter **admin** as login and the password provided by Origalyr.

- Click **OK**. You are now logged as the Administrator.

3. It is recommended to create one or several user account as follows:

- In the **User** group of the **Settings** ribbon, click the **New** icon.



- In the New user window, enter the user parameters (Name, First name, E-mail, Department, Login, Level, Password (6 alphanumerical characters minimum and case sensitive) and Comments).

3 user levels are available:

- **Administrator:** controls all the user database (can create, edit and suppress user accounts), can create edit and run methods and view experimental results of any Operator and Supervisors.
- **Supervisor:** can be the department manager as he can create edit and run methods and view experimental results of any Operators.
- **Operator:** can create edit and run methods and view only his own experimental results (cannot view the results issued from other users).

- Click **OK** to close the New User window. Click **OK** to confirm the user creation.

4. Log you on this new user as follows:

- Click the **Lock** icon of the Home Ribbon  .

- Click the **UnLock** icon of the Home Ribbon  .

- In the **User Identification** box, enter the Login and the Password already entered above and click **OK**. You are now logged as a new user. The Login is displayed on the right bottom end of the Origaviewer screen.

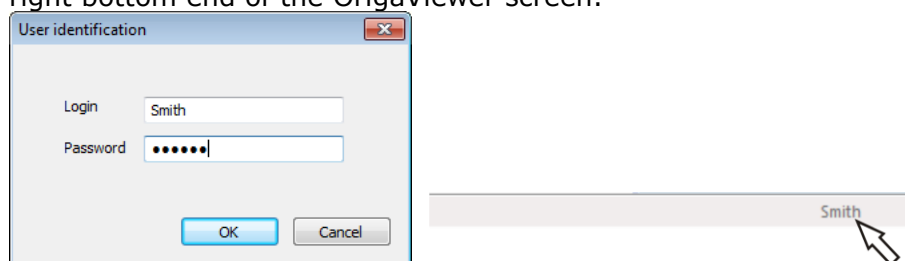

5. Origaviewer logoff automatically the current user if no keyboard action is done within a user-defined time delay. You can change the auto-logoff delay as follows (Administrator level access only):

- Log you on as Administrator,
- In the **User** group of the **Settings** ribbon, click the **Timer** icon.

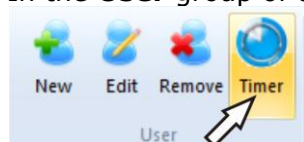

You can also select **Timer** in the **Diagram Items** group of the **Sequence** ribbon.

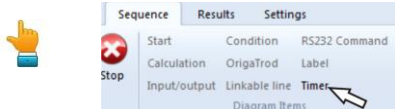

- In the **Pending disconnection** window, enter the delay in minutes and click **OK**.

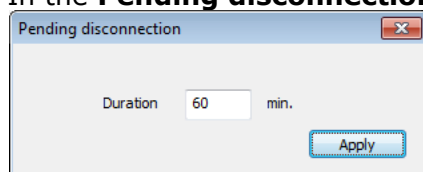

8. Configuring each OrigaFlex system

The OrigaFlex system is automatically detected by OrigaViewer provided that each drive unit is properly connected to the PC and is connected to the mains and powered (See [Connecting the OrigaFlex drive units to the PC](#)).

- Check that the OrigaFlex systems are correctly detected as follows:
 - Log you on as Administrator,
 - In the **System** group of the **Settings** ribbon, click the **Configuration** icon.

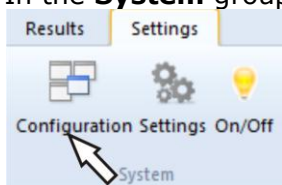

- In the **Configuration** window are listed the OrigaFlex systems that are detected and ready to be used. Each line represents one OrigaFlex. Each OrigaFlex is displayed with an IP address, the Dummy cell operation status and the OrigaFlex units connected (1 to 10 OrigaFlex, columns "pos 0" to "pos 9"). In the example below, 2 OrigaFlex systems (Unit = 1 and 3) have been detected and are in use. The OrigaFlex system (Unit = 2) exists in the database but is not connected yet.

Unit	IP	Dummy	pos 0	pos 1	pos 2	pos 3	pos 4	pos 5	pos 6	pos 7
<input checked="" type="checkbox"/> 1	192.168.0.6	NO	OGF05A	OGF05A	OGF05A	OGF05A				
<input type="checkbox"/> 2	192.168.0.4	NO								
<input checked="" type="checkbox"/> 3	192.168.0.7	NO	OGF500							

Figure 8: The Configuration window

- For each OrigaFlex system, define the Dummy cell operating status:
 - For the Unit line 1, double click in the Dummy cell the click the arrow [Rep. 1].
 - In the list provides select the Dummy cell function mode (CV, EIS, LIN or NO if you do not intend to use the built-in dummy cell of the OrigaFlex drive unit).

Unit	IP	Dummy
<input checked="" type="checkbox"/> 1	192.168.0.8	NO
<input type="checkbox"/> 2	192.168.0.4	NO
<input type="checkbox"/> 3	192.168.0.6	NO

➔

Unit	IP	Dummy
<input checked="" type="checkbox"/> 1	192.168.0.8	CV
<input type="checkbox"/> 2	192.168.0.4	EIS
<input type="checkbox"/> 3	192.168.0.6	LIN
		NO



For more information about the Dummy cell operating modes, see [Using the OrigaFlex built-in dummy cell](#).

- In the **Configuration** window, click the Dummy cell fixing icon .

- In the **Configuration** window, click the Channel numbering icon . The Channel LED panel of each OrigaFlex displays a number (001 to corresponding to the position of the unit in the connection chain).

Example:

2 OrigaFlex are used, the first has 4 OGF05A connected and the second only one OGF500.

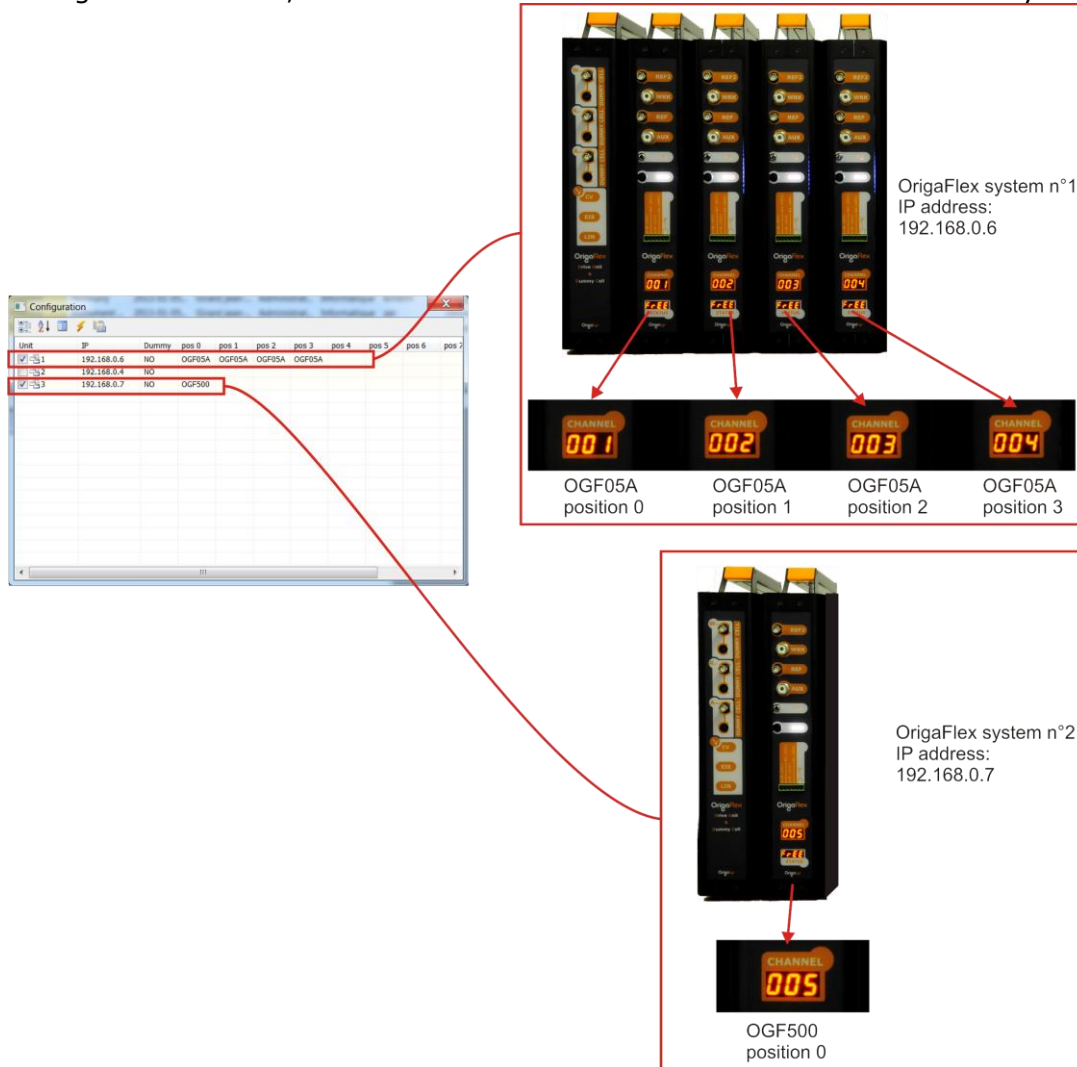

- Save the current settings by clicking the save configuration icon then close the Configuration window

9. The Origaviewer Main window

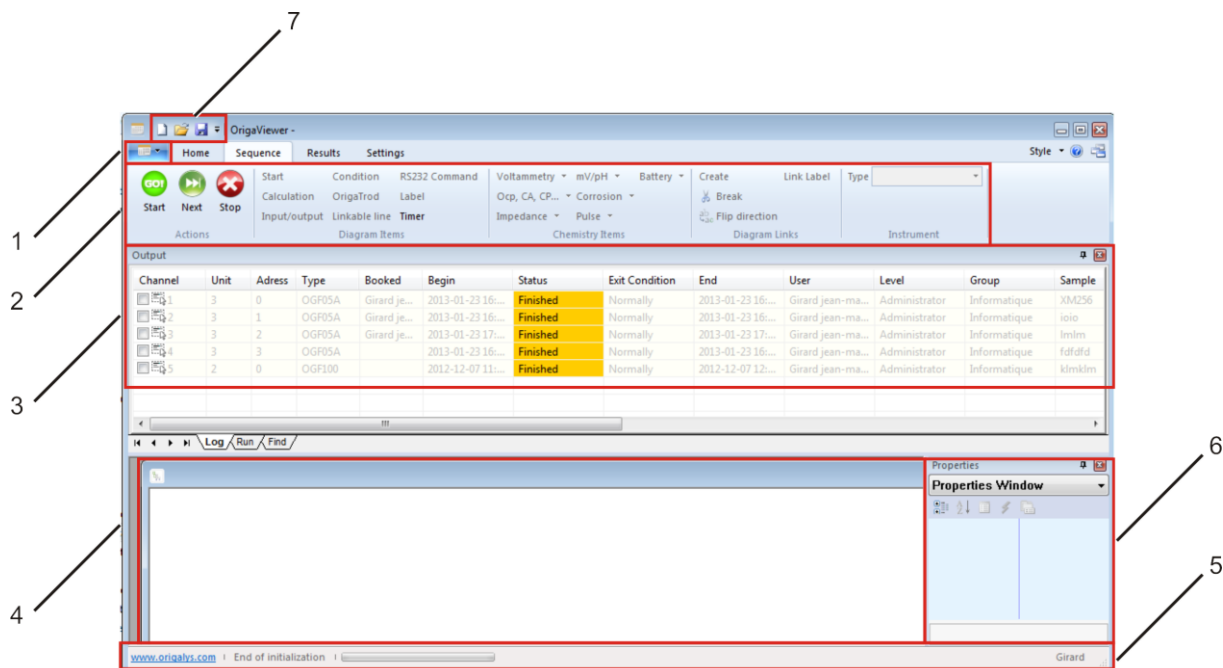

Figure 9: Main window

9.1 ORIGAVIEWER BUTTON (REF. I)

Click this button to create, to open, to save or to print a new Origaviewer file (experiment or curve file).

9.2 RIBBON (REF. 2)

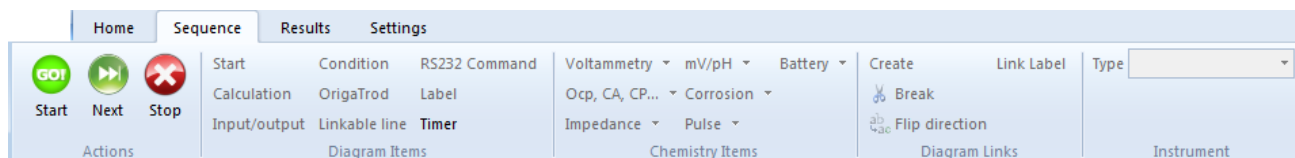



Figure 10: Ribbon

The Ribbon is designed to help you quickly find the commands that you need to complete a task. Commands are organized in logical groups, which are collected together under tabs. Each tab relates to a type of activity, such as:

- **Home tab:** Clipboard, view and new window commands
- **Sequence tab:** all the tools that are required to edit and run an experiment
- **Results tab:** all the tools that are required to search results by running out requests from the result database
- **Settings tab:** direct access to the setup parameters of your hardware system

1. You can minimize the Ribbon to make more space available on your screen.

- Click Customize Quick Access Toolbar Button image .
- In the list, click "Minimize the Ribbon"..

To use the Ribbon while it is minimized, click the tab you want to use, and then click the option or command you want to use.



For example, with the Ribbon minimized, you can start an experiment by clicking the Sequence tab, and then in the Action group, clicking the Start command. After you click the Start command, the Ribbon goes back to being minimized

2. Keep the Ribbon minimized for a short time. To quickly minimize the Ribbon:

- Double-click the name of the active tab.
- Double-click a tab again to restore the Ribbon.

3. Restore the Ribbon to its original size

- Click Customize Quick Access Toolbar Button image .
- In the list, click "Minimize the Ribbon".



Keyboard shortcut: To minimize or restore the Ribbon, press CTRL+F1.

9.3 OUTPUT VIEW FRAME (REF. 3)

Output													
Channel	Unit	Address	Type	Booked	Begin	Status	Exit Condition	End	User	Level	Group	Sample	Meth.Name
1	3	0	OGF05A	Girard je...	2013-01-23 16:...	Finished	Normally	2013-01-23 16:...	Girard jean-ma...	Administrator	Informatique	XM256	chrono.flw
2	3	1	OGF05A	Girard je...	2013-01-23 16:...	Finished	Normally	2013-01-23 16:...	Girard jean-ma...	Administrator	Informatique	ioio	chrono.flw
3	3	2	OGF05A	Girard je...	2013-01-23 17:...	Finished	Normally	2013-01-23 17:...	Girard jean-ma...	Administrator	Informatique	lmlm	chrono.flw
4	3	3	OGF05A		2013-01-23 16:...	Finished	Normally	2013-01-23 16:...	Girard jean-ma...	Administrator	Informatique	fdfdfd	chrono.flw
5	2	0	OGF100		2012-12-07 11:...	Finished	Normally	2012-12-07 12:...	Girard jean-ma...	Administrator	Informatique	klmklm	New 1.flw

Figure 11: Ouput view frame

The Output view frame is a table listing each Origaflex unit (channel) in use.

Each line represents an Origaflex (OGFxxx) with all the following information:

1. Channel number
2. Origaflex Drive unit associated
3. IP address of this Drive unit associated
4. Type of Origaflex (OGF500, OGF01A, OGF05A or OGF10A)
5. Name the user who has booked this channel
6. Date and time of the last experiment start
7. Operation state of the channel (Finished, Busy or Ready)
8. Exit condition of the last experiment run (Normally or Error)
9. Date and time of the last experiment end
10. Name of the user who ran the last experiment on that channel
11. Access level of the user who ran the last experiment on that channel
12. Department name (group) of the user who ran the last experiment on that channel
13. Sample selected for the channel and to be run if a Start command is initiated on that channel.
14. Sequence of methods selected for the channel and to be run if a Start command is initiated on that channel.



Other channel data are displayed in the Output frame. These not significant data are not described in this Getting started guide.

9.3.1 Operations on Output view Frames

To move the frame: Drag the toolbox by the top bar.

To replace the frame to its original place: Double click the top bar.

To hide the frame: Click the mouse right button over the top bar of the Output view frame and select **Auto hide**.



When the Auto hide function is activated, the frame is minimized to a button . Move the mouse pointer over this button to display the toolbox for a while.

To disable the Auto hide function and display the frame permanently: Move the mouse pointer over the **Output** button (see above) then click the **Auto hide** button in the top bar.

To close (or permanently hide) the frame: Click the close button in the top bar.

To open (or permanently display) a closed frame: select the click **Output view** in the **View group** of the **Home** ribbon.

9.4 MAIN FRAME (REF. 4)

The Main frame is used to create and edit sequences. In this area, the experiment is displayed as a sequence of methods.

9.5 STATUS BAR (REF. 5)

The Status bar displays the Origaviewer working status, a progress bar while an experiment is running and the name of the user logged on.

To display or hide the status bar, click the Home tab in the Ribbon then click the Status Bar command in the View group.

9.6 PROPERTIES TOOLBOX (REF. 6)

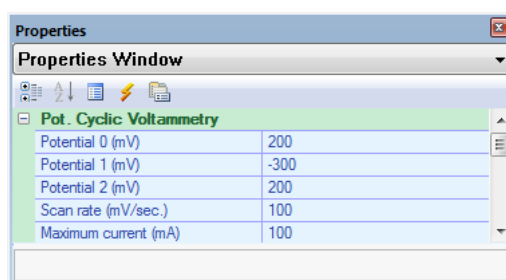





Figure 12: Properties Toolbox

The **Properties** toolbox is originally placed below the ribbon of the Origaviewer window.

It shows the operating parameters of the method selected in the Main frame. These parameters can therefore be edited as for a Pot (Cyclic Voltammetry in the above example).

The **Properties** toolbox offers an information box that describes shortly the parameter being edited.

A set of icons is available:

-  for showing or hiding the menu tree of parameters
-  for sorting the parameters in alphabetical order
-  for displaying information about the method programmed (number of measurement points, total duration of a method run,...)
-  for displaying the shape of the signal imposed to the electrodes

9.6.1 Operations on Properties toolboxes

To move the toolbox: Drag the toolbox by the top bar.

To replace the toolbox to its original place: Double click the top bar.

To hide the toolbox: Click the mouse right button over the top bar of the Properties toolbox and select **Auto hide**.

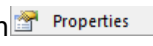
-  When the Auto hide function is activated, the toolbox is minimized to a button . Move the mouse pointer over this button to display the toolbox for a while.

To disable the Auto hide function and display the toolbox permanently: Move the mouse pointer over the **Properties** button (see above) then click the **Auto hide** button in the top bar.

To close (or permanently hide) the toolbox: Click the close button  in the top bar.

To open (or permanently display) a closed frame: select the click **Properties view** in the **View group** of the **Home** ribbon.

9.7 QUICK ACCESS TOOLBAR (REF. 7)

The OrigaViewer Quick Access Toolbar is a customizable toolbar that contains a set of commands. You can display the Quick Access Toolbar below or above the ribbon, and you can add buttons that represent commands to the Quick Access Toolbar.

1. Moving the Quick Access Toolbar

The Quick Access Toolbar can be located in one of two places:

- Upper-left corner next to the OrigaViewer Button (default location),
- Below the Ribbon, which is part of the Microsoft Office Fluent user interface.

If you don't want the Quick Access Toolbar to be displayed in its current location, you can move it to the other location. If you find that default location next to the OrigaViewer Button is too far from your work area to be convenient, you may want to move it closer to your work area. The location below the Ribbon encroaches on the work area.

Therefore, if you want to maximize the work area, you may want to keep the Quick Access Toolbar in its default location.

- Click Customize Quick Access Toolbar Button image .
- In the list, click **Show Below the Ribbon** or **Show Above the Ribbon**.

2. Adding a command to the Quick Access Toolbar

You can add a command to the Quick Access Toolbar directly from commands that are displayed on the OrigaViewer Fluent Ribbon.

- On the Ribbon, click the appropriate tab or group to display the command that you want to add to the Quick Access Toolbar.
- Right-click the command, and then click **Add to Quick Access Toolbar** on the shortcut menu.

10. Editing and running my first experiment

10.1 DECLARING THE ORIGAFLEX SYSTEM

You must declare to Origaviewer the type of Origaflex you have connected to a given channel before editing and starting a sequence on that channel.

1. In the **Instrument** group of the **Sequence** ribbon, click the down arrow of the **Type** item.



10.2 EDITING THE CHANNEL PARAMETERS

The channel parameters are displayed in the Output frame of the Origaviewer Main window. See [Output frame \(ref. 3\)](#).

Channel	Unit	Address	Type	Booked	Begin	Status	Exit Condition	End	User	Level	Group	Sample	Meth.Name
1	3	0	OGF05A		2013-01-23 16:...	Finished	Normally	2013-01-23 16:...	Girard jean-ma...	Administrator	Informatique	klmklm	chromo.flw
2	3	1	OGF05A	Girard je...	2013-01-23 16:...	Finished	Normally	2013-01-23 16:...	Girard jean-ma...	Administrator	Informatique	ioio	chromo.flw
3	3	2	OGF05A	Girard je...	2013-01-23 17:...	Finished	Normally	2013-01-23 17:...	Girard jean-ma...	Administrator	Informatique	lmim	chromo.flw
4	3	3	OGF05A		2013-01-23 16:...	Finished	Normally	2013-01-23 16:...	Girard jean-ma...	Administrator	Informatique	fdffd	chromo.flw
5	2	0	OGF100		2012-12-07 11:...	Finished	Normally	2012-12-07 12:...	Girard jean-ma...	Administrator	Informatique	klmklm	New 1.flw

1. Identify the Channel number (i.e. the dedicated line of the Output frame table, for example channel number 2 (ref. 1)).
2. Optional step: book the channel so that you are the only person that can edit and/or start a sequence on that channel:

- With the mouse right click in the table channel line and select the **Booking** command

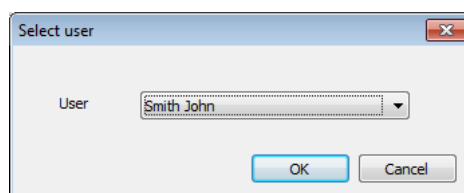
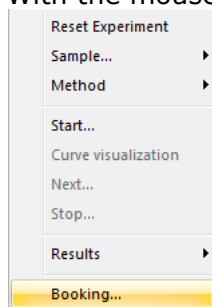

- In the **Select user** window, select the User then click **OK**. The name is displayed in the **Booked** column (ref. 2).
3. Optional step: Create a sample to be run on that channel.

- With the mouse right click in the table channel line and select the **Sample > New** command.

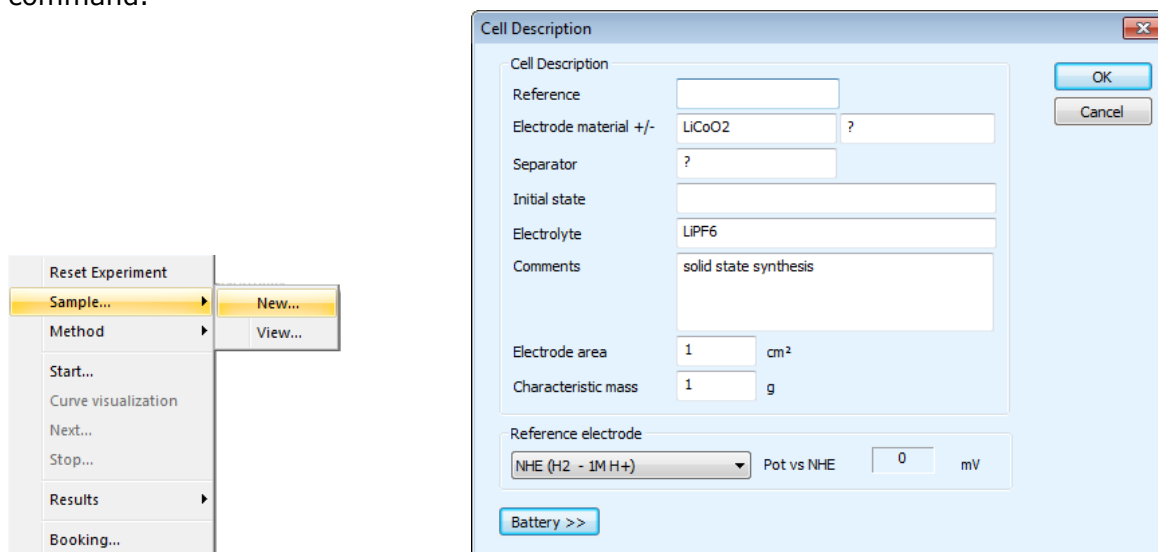

- In the Cell Description window, enter a reference name for the sample and edit the sample parameters. You can click the Battery button and edit parameters dedicated to battery charge/discharge processes.
- Click OK. The sample name is displayed in the Sample column (see [Editing the Channel parameters](#), (ref. 3)).



You can also simply visualise by right clicking in the table channel line and selecting the **Sample > View** command.

4. Create and save the sequence of method to be run on that channel.
5. Load that sequence of method for the selected channel.



We suppose that the sequence exists, that is to say has been edited. If this is not the case, create and edit that sequence of methods. See [Creating an experiment file](#).

- With the mouse right click in the table channel line and select the **Method > Load** command.

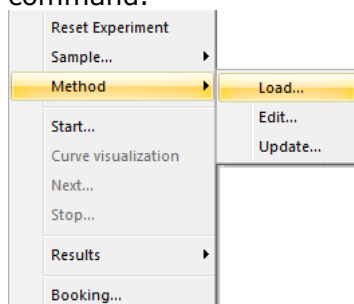

- In the **Open** window, select the flw file in the appropriate folder and click Open. The name of the sequence file is displayed in the Method name column (see [Editing the Channel parameters](#), (ref. 4)).

If the sequence selected for the channel exists in memory, you can right-click in the table channel line and select the **Method > Edit** command.

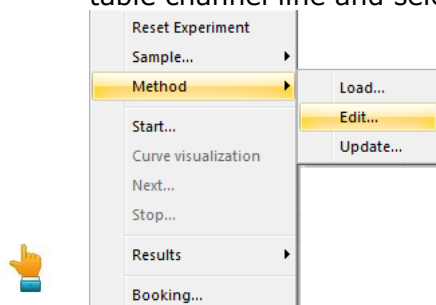

This action displays the sequence of methods in a new Origaviewer frame so that you can edit and save the file under the same name and another name of your choice.

- If the sequence is saved under the same name, you must right-click in the table channel line and select the **Method > Update** command to take the new changes into consideration.
- If the sequence is saved under another name, use the Method > Load command as shown above to assign this new sequence to the channel.

6. Start the sequence on that channel.

With the mouse right click in the table channel line and select the **Start** command.

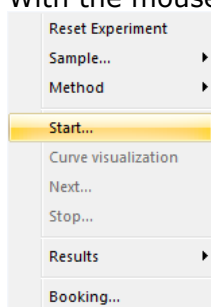

You can edit several channels repeating steps 1 to 6 above the run the attached sequence simultaneously.

Use the CTRL or SHIFT key to select consecutive or separate channels (for example channels 1, 2 and 3).

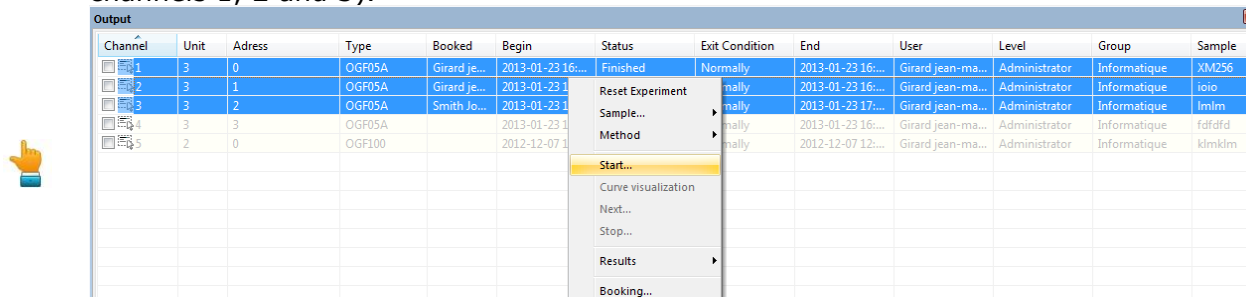

Right-click in the table channel line and select the **Start** command to run simultaneously the sequence (in the example, 3 Origaflex runs a sequence in the time).

10.3 CREATE AN EXPERIMENT

An experiment is a chain of methods (or items). An experiment must be initiated with the **Start** item then you can add every kind of methods depending on your needs.

Do not forget to insert a **Start** item at the first step of your experiment. If not, the OrigaFlex system will not be able to run the experiment because OrigaViewer has no information about the electrode system used.

1. In the Quick access toolbar of the OrigaViewer Main window, click the icon. A new window named "New1" is created. You have created a new experiment.
2. Insert a **Start** item at the first step of your experiment:

- In the **Diagram items** group of the **Sequence** ribbon, click on **Start**. The pointer of the mouse is changed to a cross.

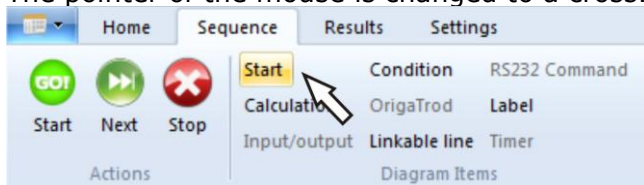

- Move the cross above the experiment frame and click. The Start item is displayed in the experiment frame as shown below.

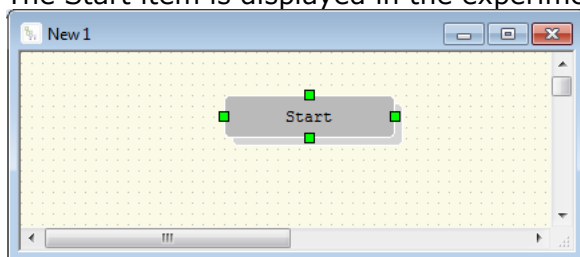

3. Inserting a second item to your experiment, for example "Pot Cyclic Voltammetry"

- In the **Chemistry Items** group of the Sequence ribbon, click on the arrow at end of line Voltammetry.
- In the list displayed, click on **Pot. Cyclic Voltammetry**. The pointer of the mouse is changed to a cross.

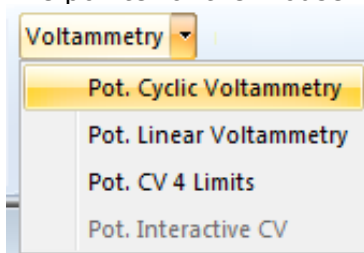

- Move the cross above the experiment frame and click. The **Pot. Cyclic Voltammetry** item is displayed in the experiment frame as shown below. Now, the experiment is made of 2 items (**Start** and **Pot. Cyclic Voltammetry**).

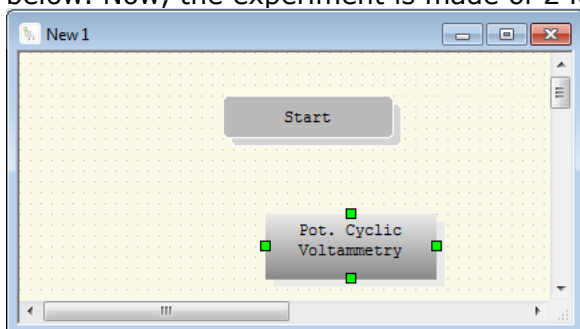

4. Repeat steps 2 and 3 to add other items to the sequence. You can pick up items from both **Diagram Items** or **Chemistry Items** groups.
5. Link the items together
The next step is to inform OrigViewer in which order the methods are being executed. Links must be created between items.
 - Drag a marquee over all of the items or with an item selected, hold on the CTRL key and click over other items to select. Green square handles indicate that the method is selected. After selection of the 2 items, the screen must be as follows:

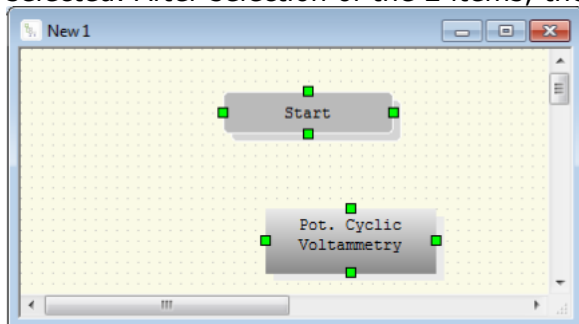

- In the **Diagram links** group of the **Sequence** ribbon, click on **Create**.

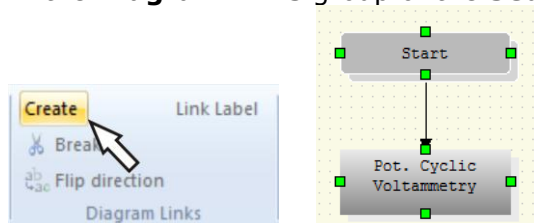

The link is created. An arrowed line indicated that the **Pot. Cyclic Voltammetry** follows the **Start** method.

- Define the other links in the same way. Any items of the experiment must be linked with another item.
Now, the experiment is a chain of items linked together and started with the **Start** item.

To erase a link: select (click) on the link then click **Break** in the **Diagram links** of the **Sequence** ribbon.



To reverse the direction of a link: select (click) on the link then click **Flip direction** in the **Diagram links** of the **Sequence** ribbon.

10.4 CREATE A CONDITIONAL LOOP SEQUENCE

Conditional loop sequence are used to force Origaviewer to repeat one or more methods depending on conditions set in a dedicated method so-called "Condition"

1. Create a sequence including a Condition method. The condition is based on a calculation formula set in another method (Calculation method). With this 5-method sequence, Pot. Cyclic Voltammeteries will be carried out at increasing Origatrod rotation speeds (from 100 rpm up to 1000 rpm in steps of 100 rpm).

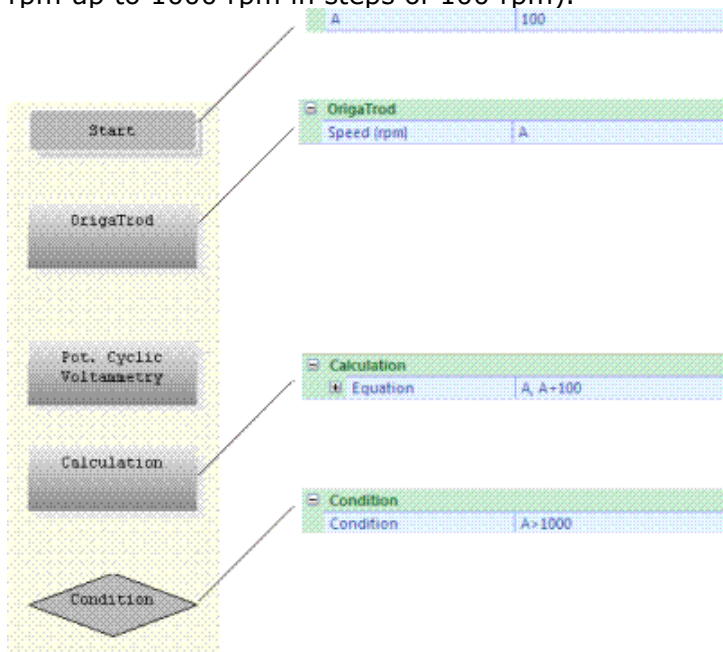

2. Link together the 5 methods. See [Create an experiment](#), step 5.

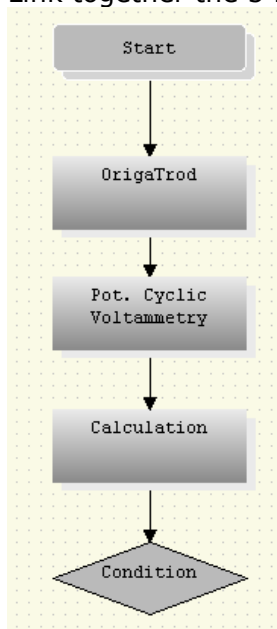

3. In the **Diagram Items** of the **Sequence** ribbon, click the **Linkable line** command.

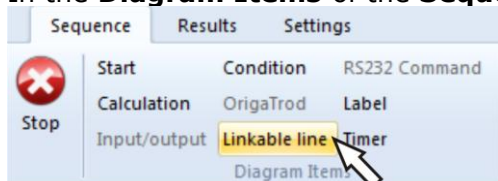

4. Draw a vertical line as shown below.

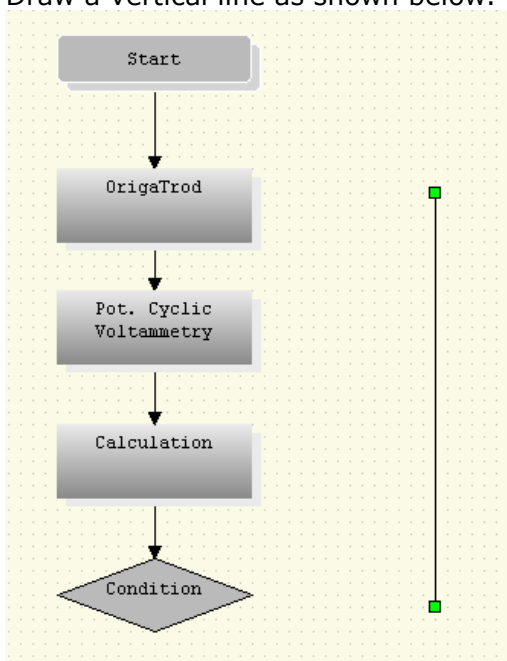

5. Select both vertical line and the OrigaTrod methods (click the vertical item, hold on the Ctrl key depressed then select the OrigaTrod item).

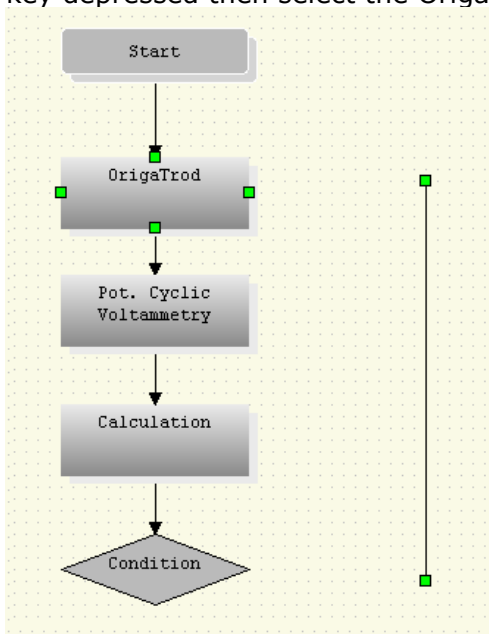

6. In the **Diagram links** of the **Sequence** ribbon, click on **Create**.

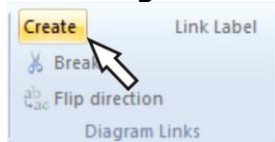

7. Reverse the direction of the link clicking **Flip direction** in the **Diagram links** of the **Sequence** ribbon.

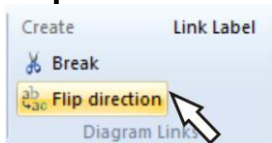

- Select both vertical line and the Condition methods (click the vertical item, hold on the Ctrl key depressed then select the Condition item).

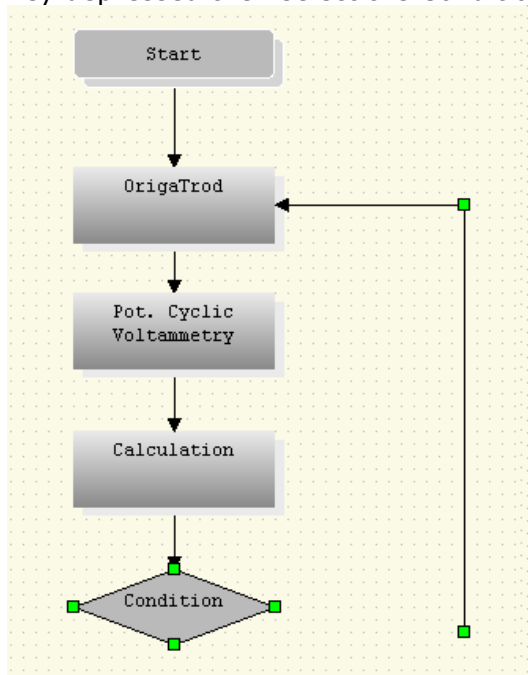

- In the **Diagram links** of the **Sequence** ribbon, click on **Create**.

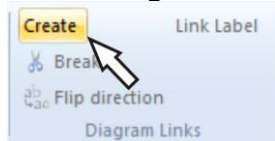

Now, the conditional loop is programmed and the experiment ends when the OrigaTrod will reach the 1000 rpm rotation speed.

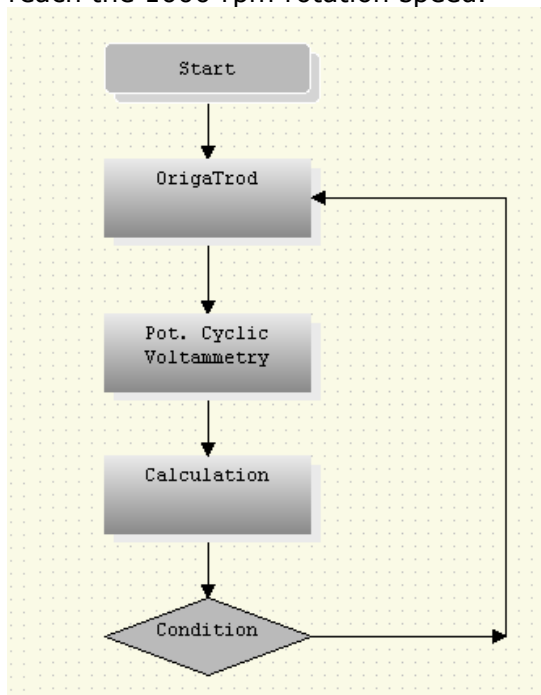

10.5 EDIT EACH METHOD OF THE EXPERIMENT

1. Select the item (method) you want to edit.
The current parameters of the method selected are displayed in the **Properties** dialog box on the right side of the Origaviewer window.

2. Enter the parameters of this method in the **Properties** dialog box.

Example of the **Start** and **Pot. Cyclic Voltammetry** Properties dialog boxes:

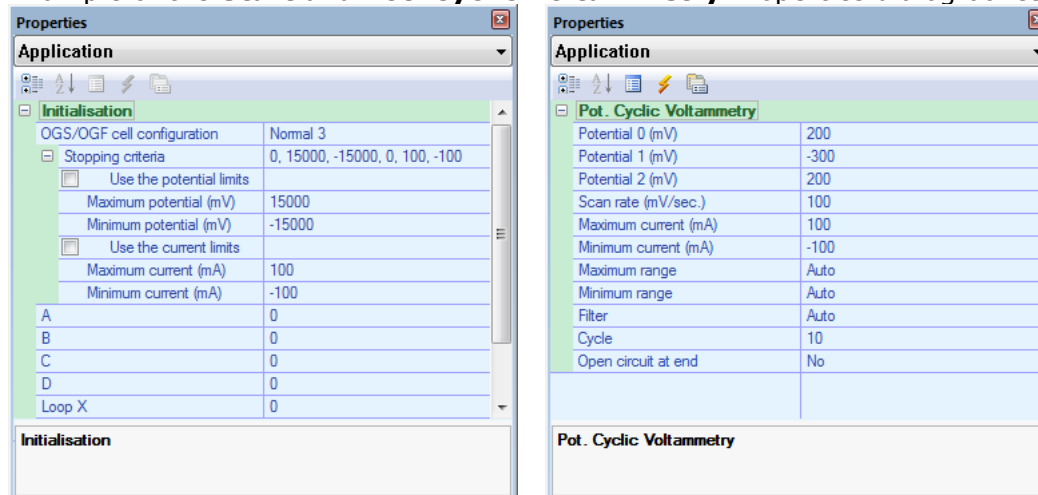

3. Repeat steps 1 and 2 for all the methods of the experiment.



In particular, pay attention to the Cell configuration parameter of the **Start** method: select the cell configuration (Normal 2, Normal 3, Normal 4, Inverted 2 or Inverted 3) corresponding to your electrode setup.

10.6 SAVING AND RENAMING THE EXPERIMENT

- In the Quick access toolbar, click the  icon.
- In the **Save As** dialogue box, the following options allow you to specify the name and location of the experiment file you're about to save:
 - Save in
Select the folder in which you want to save the file. You can also double-click a folder or a file in that box to select it.
 - File name
Type a new file name to save the sequence with a different name. The FLW extension is added by Origaviewer. The default extension .FLW must be kept so that Origaviewer can read the sequence name on loading this sequence later on.
 - Save as type
Keep the Origaviewer extension file (.FLW) displayed in that box.
- Select the **OK** button to save the sequence with the name and the location selected.

10.7 RUNNING THE EXPERIMENT



Before running sequence, make sure that you have correctly edited all the channels you want to run (See [Editing the Channel parameters](#)).

In the Output frame (see [Output frame \(ref. 3\)](#)):

1. Select the channels you want to run (for example channels 1, 2 and 3).

Channel	Unit	Address	Type	Booked	Begin	Status	Exit Condition	End	User	Level	Group	Sample
1	3	0	OGR05A	Girard je...	2013-01-23 16:...	Finished	Normally	2013-01-23 16:...	Girard jean-ma...	Administrator	Informatique	XM256
2	3	1	OGR05A	Girard je...	2013-01-23 16:...	Normally	Normally	2013-01-23 16:...	Girard jean-ma...	Administrator	Informatique	ioio
3	3	2	OGR05A	Smith Jo...	2013-01-23 16:...	Normally	Normally	2013-01-23 17:...	Girard jean-ma...	Administrator	Informatique	Imim
4	3	3	OGR05A		2013-01-23 16:...	Normally	Normally	2013-01-23 16:...	Girard jean-ma...	Administrator	Informatique	fdfdfd
5	2	0	OGF100		2012-12-07 12:...	Normally	Normally	2012-12-07 12:...	Girard jean-ma...	Administrator	Informatique	klmklm

2. Right-click in the table channel line and select the **Start** command to run simultaneously the sequence (in the example, 3 OrigaFlex starts a sequence in the time).
or in the **Actions** group of the **Sequence** ribbon, click the **Start** icon.

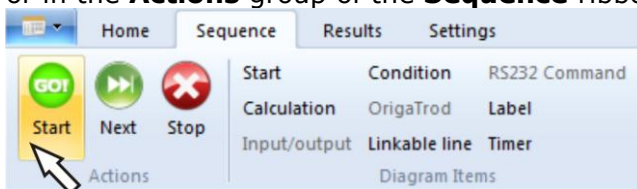

3. The experiment starts. The methods are chained one after the other on the selected channels. To view the real time curves, click the **Run View** command in the **Real Time** group of the **Settings** ribbon.

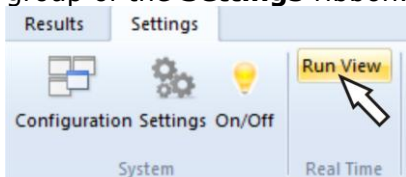

A 10-square window is opened. This window will display the real time curves of up to 10 running channels.

Example: Chrono-amperometries run simultaneously on 10 channels

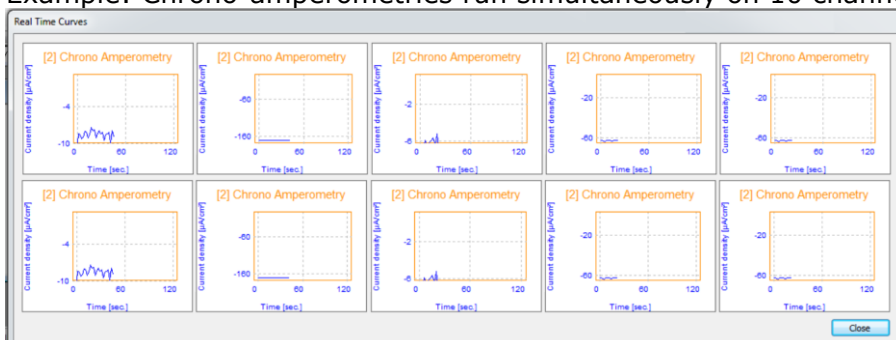

While an experiment is running on a channel, the corresponding OrigaFlex unit displays "busy" and the electrode inputs lamps are lit (these lamps show the electrode setup used on that channel).

All curves are automatically saved as a ".CRV" in the Result folder of the OrigaViewer installation directory.

4. While an experiment is running on a channel, 2 other action icons are available:
- The Next icon: stops the method in progress on the channel selected and jumps to the next method of the sequence.



You can also right-click the channel line in the table and select the **Next** command.

- The Stop icon: stops definitely the experiment on the channel selected. The methods coming next are not executed.

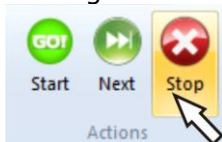

You can also right-click the channel line in the table and select the **Stop** command.

II. Loading curves in deferred time

- In the Output frame (see [Output frame \(ref. 3\)](#)), select the channel you want to display the curve (for example channels 1, 2 and 3).
- Right-click in the table channel line and select the **Results > Curves** command.

Channel	Unit	Adress	Type	Booked	Begin	Status	Exit Condition	End	User	Level	Group
1	3	0	OGF05A	Girard je...	2013-01-23 16:...	Finished	Normally	2013-01-23 16:...	Girard jean-ma...	Administrator	Informatique
2	3	1	OGF05A	Girard je...	2013-01-23 16:...	Normally	Normally	2013-01-23 16:...	Girard jean-ma...	Administrator	Informatique
3	3	2	OGF05A	Smith Jo...	2013-01-23 16:...	Normally	Normally	2013-01-23 17:...	Girard jean-ma...	Administrator	Informatique
4	3	3	OGF05A		2013-01-23 16:...	Normally	Normally	2013-01-23 16:...	Girard jean-ma...	Administrator	Informatique
5	2	0	OGF100		2012-12-07 12:...	Normally	Normally	2012-12-07 12:...	Girard jean-ma...	Administrator	Informatique

- Select the method the curve is coming from then click **OK**.

Step	Date	Method
1	2013-01-23 16:41:23	Chrono Amperometry

- You can also overlay in a graph several curves coming from the same channel:
Right-click in the table channel line, select the **Results > Overlay** command then select the curves to be overlaid.

12. Searching results

You can create and save queries to extract results satisfying one or several criteria such as the name of the operator who run the experiment, the channel number, etc.

1. In the **View** group of the **Results** ribbon, click on **Search**.

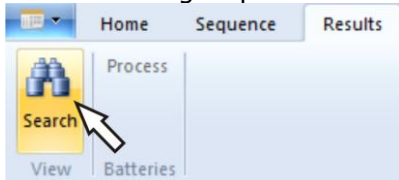

2. In the Search results, click the Create a new query icon on the upper left corner of the search results window.

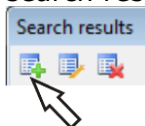

3. Click Yes to confirm that you want to create a query.
4. In the **Query** window, type a name for the **Query ID** then click **Add**.

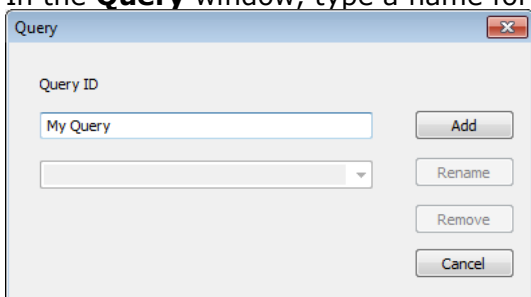

5. Edit the Query by defining one or several criteria then click the Search button. The Results box (ref.1) displays the number of results found.

Example:

36 results have been obtained in January 2013 by running Chrono Potentiometries on channel 2.

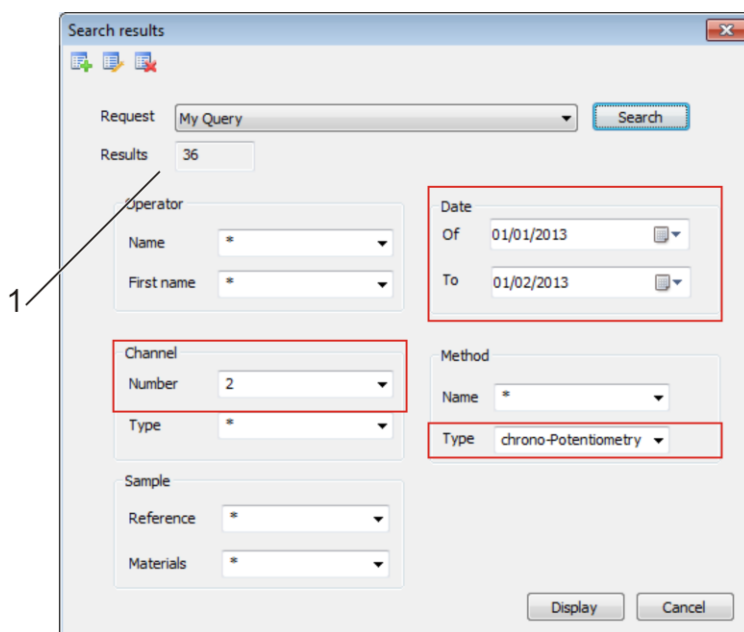
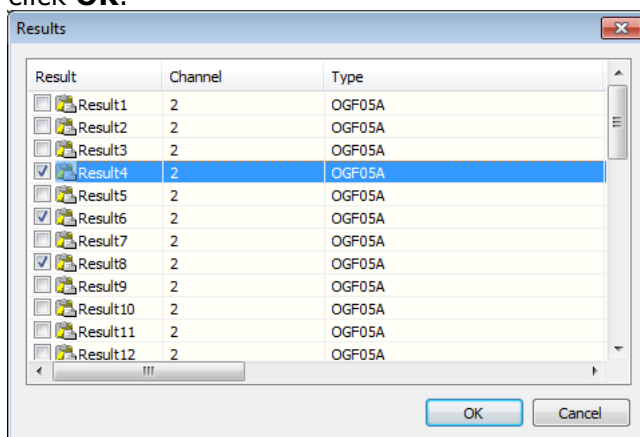

Figure 13: Search results

- To display the results, click the **Display** button, select the results you want to display then click **OK**.



13. Quitting Origaviewer

To quit Origaviewer, you must be logged as an Operator, Supervisor or Administrator user.

- Press simultaneously keys **ALT** and **F4** or double click the arrow (ref. 1) on the left upper corner of the Origaviewer screen

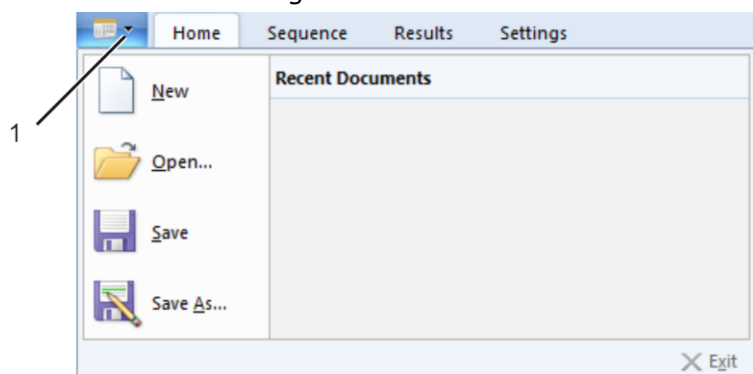

- In the next window, click **Yes** to confirm.